

# BOTT®



## Measures



## Wristbands



## Seals

# Catalog

2025/2026

# TABLE OF CONTENTS

p. 2	<b>Table of contents</b>	p. 25	<b>Knife Lizard</b>	p. 34	<b>One &amp; Few-days wristbands</b>
p. 3	<b>Techniques used for printing</b>	p. 26	<b>Cleaning brush Nozzle+</b>	p. 38	<b>Festival wristbands</b>
p. 4	<b>Spoons</b>	p. 26	<b>Dial caliper MIL+</b>	p. 40	<b>Crimper tool</b>
p. 7	<b>Measures</b>	p. 27	<b>Seals SIBO, SIBO-L</b>	p. 41	<b>Waffle</b>
p. 12	<b>Scoops</b>	p. 28	<b>Seals SIBO-BAG</b>	p. 42	<b>Tokens</b>
p. 14	<b>Buckets</b>	p. 29	<b>Veterinary seals</b>	p. 43	<b>Event cups</b>
p. 18	<b>Yellow TRAP</b>	p. 30	<b>Sealed bottles</b>		
p. 19	<b>Measuring quadrats</b>	p. 31	<b>Cylinder seals</b>		
p. 20	<b>Rain Gauges</b>	p. 32	<b>Seal SibO-Pastil 10</b>		
p. 22	<b>Thermometer SOIL</b>	p. 32	<b>Sachets Cryptex</b>		
p. 24	<b>Thermometer Thermo 19/27</b>	p. 32	<b>Crimpers SIBO-BAG</b>		
p. 25	<b>Oil can JUMBO</b>	p. 33	<b>List of seals</b>		

## SIGNS & SYMBOLS

	total height [mm]		the product is dishwasher safe at the specified maximum temperature (°C)
	overall width [mm]		suitable for use in the microwave oven
	total length [mm]		recycled product (granulate)
	diameter [mm]		polypropylene, a product of the safe plastic group (recyclable)
	total volume [ml]		polyethylene, a product of the safe plastic group (recyclable)
<b>LOGO</b>	marking area (width * height) [mm]		product for multiple use
	print possible in various colours		carton, number of items per carton [pcs.] quantity for Poland/ quantity for Europe
	product with scale (printed or embossed)		pallet, number of items per pallet [pcs.]
	product available in other colours on request		certyfiat Prüfinstitut Chemische Analytik GmbH
	product approved for food contact (BPA free)		Certyfiat European Union Intellectual Property Office
<b>MOQ</b>	minimum order quantity		

# TECHNIQUES USED FOR PRINTING

## SCREEN PRINTING

The only method for permanent printing on plastics which allows products printed with this technique to be used in the agricultural, chemical, construction and food industries. Our screen printing inks are dishwasher safe, resistant to chemicals and abrasion. The advantage is the ability to print permanently without colour limitation, on any surface size (flat or convex).

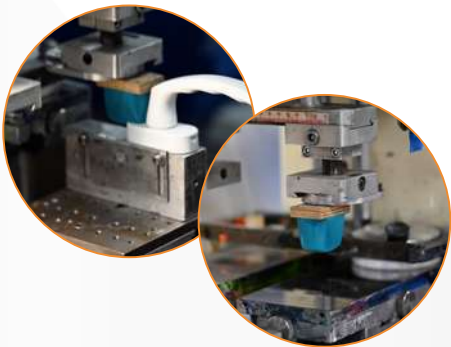

## PAD PRINTING

A method of permanent and fast printing on plastics, which that allows products printed with this technique to be used in the agricultural, chemical, construction and food industries. This printing technique is recommended for small products with a flat surfaces and limited printing areas with a small number of colours.

## HOTPRINTER

It is a single-color printing technique performed using a heated matrix. The process involves embedding the design along with a layer of ink from a foil in the desired color onto the printing surface. The result is a slightly embossed print, often in metallic colors such as gold or silver. The advantages of this method include the durability and aesthetic appeal of the print, as well as the speed of execution.

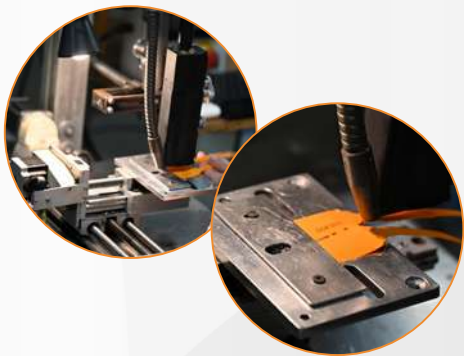

## INKJET

It is a contactless method of marking the surfaces of various materials by spray-applying colored ink onto a moving product. This technique allows for the permanent printing of not only text but also variable numbering, barcodes, and QR codes.



## LASER

Laser printing, also known as laser engraving, is an advanced technology that enables precise and durable marking of various materials, including plastics. This process is based on the use of a laser beam, which, thanks to its high energy concentrated on a small point, thermally modifies the surface of the material.



# SPOONS

## Where can you use our spoons?

- animal nutrition
- pharmaceutical industry
- poultry farms
- food supplements
- food industry
- markets
- agriculture
- restaurants





standard scale [ml]

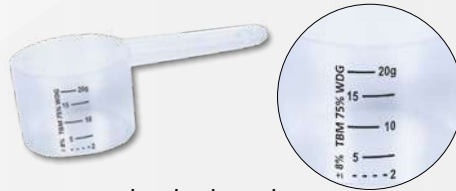

or individual scales



logo printing possible



easy packing



practical hole



spoons in Your colour



Scan

## FAMILY PIKO

STANDARD COLORS:  
MOQ 100 pcs.



COLORS  
ON REQUEST:  
MOQ 50 000 pcs.



### PIKO 1 ml

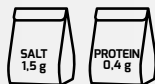

### PIKO 2 ml



PIK00002

### PIKO 5 ml



PIK00005

### PIKO 10 ml



### PIKO 20 ml



PIK00020

APPROVED FOR  
CONTACT  
WITH FOOD

## FAMILY PIKO-S

STANDARD COLORS:  
MOQ 100 pcs.



COLORS  
ON REQUEST:  
MOQ 50 000 pcs.



### PIKO-S 1 ml



PIK00030

### PIKO-S 5 ml



PIK00030

### PIKO-S 10 ml



PIK00030

### PIKO-S 30 ml



PIK00030

### PIKO-S 50 ml



PIK00050

### PIKO-S 75 ml



PIK00075

art. no	art. name	↑↓	↔	↔	⊘	📏	LOGO	☰	📦 PL/Eu	📦	features
FPIK00001	PIKO 1 ml	6	18	91	18	1	23 x 7,5	-	15000 / 12000	160000	
FPIK00002	PIKO 2 ml	10	22	94	22	2	23 x 7,5	-	11000 / 10000	112000	
FPIK00005	PIKO 5 ml	14	30	100	30	5	23 x 7,5	-	8000 / 5500	80000	
FPIK00010	PIKO 10 ml	18	36	106	36	10	23 x 7,5	-	6000 / 4000	56000	
FPIK00020	PIKO 20 ml	22	45	115	45	20	23 x 7,5	-	3000 / 2500	36000	
FPIK000015	PIKO-S 1 ml	9	15	68	15	1	23 x 7,5	-	19000 / 13000	184000	
FPIK000055	PIKO-S 5 ml	15	24	75	24	5	23 x 7,5	-	8000 / 5500	80000	
FPIK000105	PIKO-S 10 ml	19	29	78	29	10	23 x 7,5	-	6500 / 4500	60000	
FPIK00030	PIKO-S 30 ml	30	42	90	42	35	23 x 7,5	-	2250 / 1500	21600	
FPIK00050	PIKO-S 50 ml	38	46	93	46	50	23 x 7,5	-	1700 / 1300	16000	
FPIK00075	PIKO-S 75 ml	51	48	95	48	75	23 x 7,5	-	1200 / 900	12000	

## FAMILY PIKO

STANDARD COLORS:  
MOQ 100 pcs.



COLORS  
ON REQUEST:  
MOQ 50 000 pcs.



### PIKO 1 ml

PIK00001



### PIKO 2 ml

PIK00002



### PIKO 5 ml

PIK00005



### PIKO 10 ml

PIK00010



### PIKO 20 ml

PIK00020



## FAMILY PIKO-S

STANDARD COLORS:  
MOQ 100 pcs.



COLORS  
ON REQUEST:  
MOQ 50 000 pcs.



### PIKO-S 1 ml

PIK00030



### PIKO-S 5 ml

PIK00030



### PIKO-S 10 ml

PIK00030



### PIKO-S 30 ml

PIK00030



### PIKO-S 50 ml

PIK00050



### PIKO-S 75 ml

PIK00075



art. no	art. name	↑↓	↔	↔	⊘	📏	LOGO	☰	📦 PL/Eu	📦	features
PIK00001	PIKO 1 ml	6	18	91	18	1	35 x 6	-	15000 / 12000	160000	
PIK00002	PIKO 2 ml	10	22	94	22	2	35 x 7	-	11000 / 10000	112000	
PIK00005	PIKO 5 ml	14	30	100	30	5	35 x 8	-	8000 / 5500	80000	
PIK00010	PIKO 10 ml	18	36	106	36	10	40 x 8	-	6000 / 4000	56000	
PIK00020	PIKO 20 ml	22	45	115	45	20	40 x 9	-	3000 / 2500	36000	
PIK000015	PIKO-S 1 ml	9	15	68	15	1	25 x 5	-	19000 / 13000	184000	
PIK000055	PIKO-S 5 ml	15	24	75	24	5	25 x 5	-	8000 / 5500	80000	
PIK000105	PIKO-S 10 ml	19	29	78	29	10	30 x 8	-	6500 / 4500	60000	
PIK00030	PIKO-S 30 ml	30	42	90	42	35	30 x 10	✓	2250 / 1500	21600	
PIK00050	PIKO-S 50 ml	38	46	93	46	50	30 x 11	✓	1700 / 1300	16000	
PIK00075	PIKO-S 75 ml	51	48	95	48	75	30 x 11	✓	1200 / 900	12000	



# MEASURES

## Where can you use our measures?

- animal nutrition
- construction industry
- food industry
- agriculture
- beauty industry
- events, trade fairs
- advertisement
- catering
- horticulture
- chemical industry





## FAMILY NANO

### Measure NANO 150 ml / 200 ml / 400 ml



Scan



**N000150**  
MOQ 100 pcs.



**N000200**  
MOQ 100 pcs.



**N000400**  
MOQ 100 pcs.

art. no	art. name	↑↓	↔	↔	⊘	📏	LOGO	☑	📦 PL/EU	📏	features
N000150	NANO 150 ml	107	59	59	59	200	170 x 60	✓	1120 / 845	11520	
N000200	NANO 200 ml	110	66	66	66	270	160 x 80	✓	1134 / 912	12672	
N000400	NANO 400 ml	133	79	79	79	490	220 x 100	✓	650 / 500	6048	

## FAMILY SMART

### Measure SMART 500 ml

**MS00500**

MOQ 100 pcs.



### Measure SMART 1000 ml

**MS01000**

MOQ 100 pcs.



### Measure SMART 1500 ml

**MS01500**

MOQ 100 pcs.



### Measure SMART 2000 ml

**MS02000**

MOQ 100 pcs.



### Measure SMART 3000 ml

**MS03000**

MOQ 100 pcs.

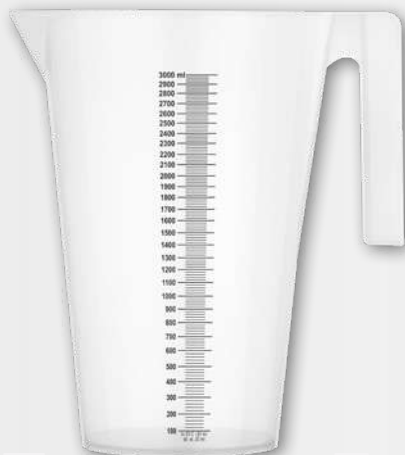

art. no	art. name	↑↓	↔	↔	⊘	📏	LOGO	☰	📦 PL/EU	📏	features
MS00500	SMART 500 ml	148	98	140	98	730	130 x 60 / 2	✓	460 / 270	4592	🍴♻️🔄
MS01000	SMART 1000 ml	183	122	175	122	1390	160 x 60 / 2	✓	210 / 144	2000	♻️ PP
MS01500	SMART 1500 ml	201	133	190	133	1800	170 x 60 / 2	✓	143 / 100	1440	🔥📏📄
MS02000	SMART 2000 ml	215	142	198	142	2200	190 x 70 / 2	✓	100 / 64	1216	MAX 95°C
MS03000	SMART 3000 ml	256	170	230	170	3750	200 x 80 / 2	✓	56 / 36	576	🔄

## Measure MUG 500 ml

M000500  
MOQ 100 pcs.



## Measure EKO 1000 ml

M001000  
MOQ 100 pcs.



## Measure TWIN 2000 ml

MT02000  
MOQ 250 pcs.



## Measure SOLID 1800 ml

M001800  
MOQ 672 pcs.



## Measure GUSTAV 5000 ml

MG05000  
MOQ 100 pcs.



imprint on the handle possible

## Measure BUCK 10 l

WM00010  
MOQ 100 pcs.



HANDLES COLOURS:



art. no	art. name	↑↓	↔↔	↔↔	⊘	📏	LOGO	☰	📦 PL/EU	📏	features
M000500	MUG 500 ml	98	92	130	92	580	180 x 80	✓	144 / 120	1680	
M001000	EKO 1000 ml	134	124	184	124	1230	100 x 85 / 2	✓	150 / 96	1344	
MT02000	TWIN 2000 ml	187	173	177	-	2080	130 x 90	✓	-	384	
M001800	SOLID 1800 ml	201	126	211	126	1900	135 x 85	✓	-	768	
MG05000	GUSTAV 5000 ml	269	208	276	208	6450	200 x 120	✓	42*	400	
WM00010	BUCK 10 l	245	296	274	274	10000	250 x 150	✓	-	1000	

\*handle without assembly



Scan



easy scoop stacking



scale on both insides

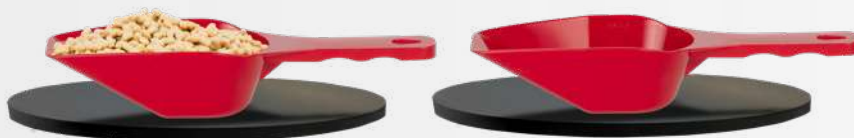

stable bottom



imprint your logo possible

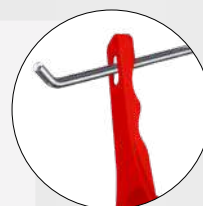

hanging hole

## FAMILY ARTHUR

### Scoop Arthur 200 g

ARTHUR200



STANDARD COLORS:

MOQ 100 pcs.



COLORS ON REQUEST:  
Individual order



### Scoop Arthur 500 g

ARTHUR500



STANDARD COLORS:

MOQ 100 pcs.



COLORS ON REQUEST:  
Individual order



### Scoop Arthur 1000 g

ARTHUR1000



STANDARD COLORS:

MOQ 100 pcs.



COLORS ON REQUEST:  
Individual order



### Scoop MEGA+ 2 kg

MEGA2000



STANDARD COLORS:

MOQ 100 pcs.



COLORS ON REQUEST:  
Individual order



- strong handle
- for economical packing both parts will be separat delivered
- after fixing the handle it is unable to remove it

art. no	art. name	↑↓	↔	↔	∅	🗄️	LOGO	☰	📦 PL/EU	🚚	features
ARTHUR200	ARTHUR 200 g	39	67	198	-	-	40 x 18	✓	850/600	8000	
ARTHUR500	ARTHUR 500 g	56	93	251	-	-	45 x 19	✓	400/300	4800	
ARTHUR1000	ARTHUR 1000 g	70	110	312	-	-	65 x 20	✓	180/160	2240	
MEGA2000	MEGA+ 2 kg	84	137	340	-	-	112 x 60 + 70 x 30/2	✓	180* 63	1760* 640	

\* handle without assembly



Scan

# BUCKETS

## Where can you use our buckets?

- animal feeding
- construction industry
- events, trade fairs
- advertisement
- social campaigns
- horticulture
- agriculture
- cleaning companies
- chemical industry
- beauty industry





safety internal handles



trade-fairs advertisement



recycling  
12 l / 16 l / 20 l



embossed scale  
inside the bucket



colourful prints  
around the bucket



possibility to print  
QR-codes



highly durable  
12 l / 16 l / 20 l





## Bucket EKO 5 l / 10 l

W000005  
W000010



**STANDARD COLORS:**  
MOQ 100 pcs.



**COLORS ON REQUEST:**  
MOQ 1000 pcs.



## Bucket STRONG 5 l / 12 l

W00C12



**WIADRO STRONG 5 L**

**STANDARD COLORS:**  
MOQ 100 pcs.



Black

**WIADRO STRONG 12 L**

**KOLORY STANDARD:**  
MOQ 100 szt.

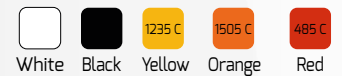

**COLORS ON REQUEST:**  
MOQ 3000 pcs.



## Bucket STRONG RECYCLING 5 / 12 l

W00CR12



**STANDARD COLORS:**  
MOQ 100 pcs.



## Bucket STRONG 12 l with funnel

W00CR12L



**STANDARD COLORS:**  
MOQ 100 pcs.



Black

## Bucket STRONG 16 L

W00C16

STANDARD COLORS:  
MOQ 100 pcs.



COLORS  
ON REQUEST:  
MOQ 3000 pcs.



## Bucket STRONG RECYCLING 16 L

W00CR16



STANDARD COLORS:  
MOQ 100 pcs.



## Bucket STRONG 20 L

W00C20

STANDARD COLORS:  
MOQ 100 pcs.



COLORS  
ON REQUEST:  
MOQ 2000 pcs.



## Bucket STRONG RECYCLING 20 L

W00CR20



STANDARD COLORS:  
MOQ 100 pcs.



## Handle soft grip

10 l / 12 l / 16 l / 20 l

M001000

MOQ 100 pcs.



## Bucket LID 12 L

LIDBLACK

STANDARD COLORS:  
MOQ 100 pcs.



art. no	art. name	↑	↗	↔	⊘	📏	LOGO	☰	📦 PL/EU	🔧	features
W000005	EKO 5 l	202	247	231	231	5350	200 x 120 /2	✓	-	1000	
W000010	EKO 10 l	245	296	274	274	10000	250 x 150 /2	✓	-	1000	
M001000	HANDLE SOFT GRIP 10 l / 12 l / 16 l / 20 l	16	11	105	-	-	-	-	1000	-	
W00C05	STRONG COLOR 5 l	203	296	240	240	5500	240 x 100 /2	✓	-	1000	
W00C12	STRONG COLOR 12 l	243	315	309	309	12000	300 x 140 /2	✓	-	1000	
W00C16	STRONG COLOR 16 l	283	359	330	330	16000	300 x 150 /2	✓	-	720	
W00C20	STRONG COLOR 20 l	288	394	357	357	20000	350 x 170 /2	✓	-	540	
W00R05	STRONG RECYCLING 5 l	203	296	240	240	5500	240 x 100 /2	✓	-	540	
W00R12	STRONG RECYCLING 12 l	243	315	309	309	12000	300 x 140 /2	✓	-	1000	
W00R16	STRONG RECYCLING 16 l	283	359	330	330	16000	300 x 150 /2	✓	-	720	
W00R20	STRONG RECYCLING 20 l	288	394	357	357	20000	350 x 170 /2	✓	-	540	
W00C12L	STRONG 12 l BLACK (WITH FUNNEL)	240	318	333	309	-	300 x 150 + 300 x 70	✓	-	800	
LIDBLACK	BUCKET LID 12 l	-	295	295	295	-	-	-	114 / 98	1440	



## Yellow TRAP-01

TRAP010  
MOQ 100 pcs.



SET CONTAINS:



## Yellow TRAP-02

TRAP020  
MOQ 100 pcs.



SET CONTAINS:



mounting bracket  
on the tube/rod Ø 20-24 mm



Scan

## Grid TRAP NET

TRAPNET1  
MOQ 100 pcs.

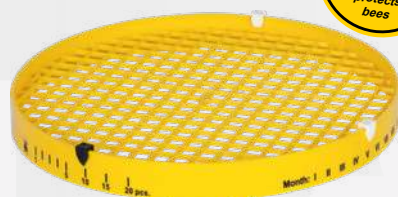

SET CONTAINS:

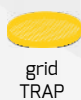

### Principles of use:

The vessel should be placed on the field just after seeding rapeseed in autumn and after the last snow melts in the spring. Install it approximately 15 m from the field edge, always at the level of the plants' top. It is recommended to use at least four vessels for each plantation.

Pour water with a bit of dishwashing detergent up to the half of the vessel's height. The addition of the detergent will reduce the surface tension of water which will make the pests immerse in it easier.

Monitor the vessel daily, i.e. count the immersed pests and read the pest limit threshold on the table printed on the vessel. Replace water in the vessel each time.

After exceeding the pest limit threshold, decide whether you want to spray the field.

The yellow vessel helps to diagnose the level of harmfulness done by such insects as: ceutorrhynchus, meligethes aeneus and dasineura brassicae.



## Frame Standard 1/10 m<sup>2</sup>

RAM00105  
MOQ 100 pcs.

## Frame Mega 1/4 m<sup>2</sup>

RAM0010M  
MOQ 100 pcs.

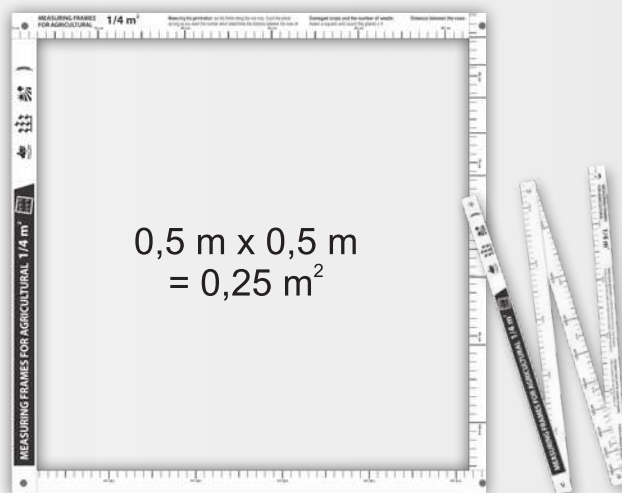
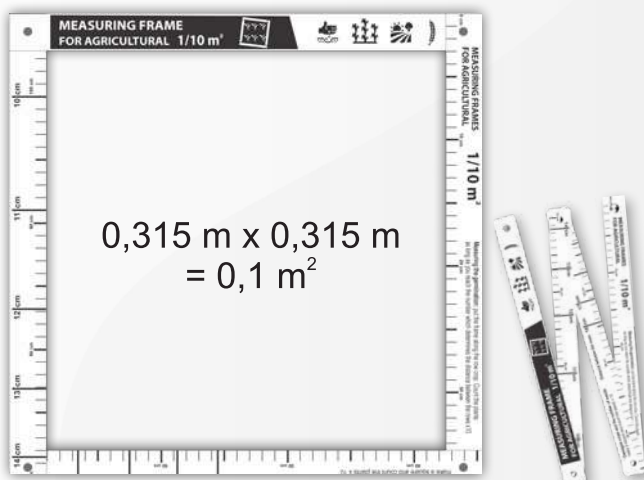

### Rules for using the FRAME measuring frame:

$(100 \text{ cm} : 18) * 10 = 55,5$

**1** Measure the distance between rows using a cm scale. In this case you get a distance of 18 cm.

**2** Place the frame along the row and count the plants on a scale based on the distance between the rows. In this case there are 32 plants

**3** Multiply the number of counted plants by 10. The result is the number of plants per qm. In this case there are 320 plants / qm

Measuring the germination of the same crop: put the frame along the row crop. Count the plants as long as you reach the number which determines the distance between the rows x10

Damaged crops and the number of weeds: make a square and count the plants x10

Distance between the rows: 18 cm

Scale connected to distance between row, here equal to 18cm

cm Scale

MEASURING FRAMES FOR AGRICULTURAL 1/10 m<sup>2</sup>

MEASURING FRAMES FOR AGRICULTURAL 1/4 m<sup>2</sup>

0 m<sup>2</sup>

18,0



Scan



## Rain gauge RAIN - EKO

D000001E  
MOQ 100 pcs.



**HANDLE COLOR:**

- Black
- 1505 C Orange
- 116 C Zóty

**SET INCLUDES:**

-  rain gauge
-  packaging
-  wooden stick holder
- OR
-  plastic stick holder



Scan



## Rain gauge RAIN FOLD - STANDARD





D000001S  
MOQ 100 pcs.



**HANDLE COLOR:**

- Black
- 1505 C Orange

**SET INCLUDES:**

-  rain gauge
-  stick-mount fixture
-  packaging box
-  plastic stick
-  adder indicators

## Rain gauge RAIN FOLD PREMIUM+

DFOLD3RO  
MOQ 100 pcs.



**HANDLE COLOR:**

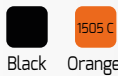

**SET INCLUDES:**



## SLEEVE - FOLD

RAINFOLDOVERLAY  
MOQ 100 pcs.



**SET INCLUDES:**

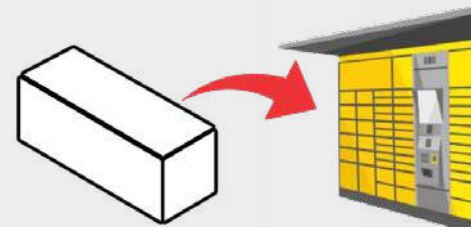

**RAIN FOLD rain gauge with a folding stick in the box facilitating further distribution**

**Characteristics of FOLD PREMIUM+ Rain Gauges:**

- vertical scale up to 40 mm with a measurement accuracy of 0.5 mm of rainfall,
- extended estimated scale up to 70 mm (storm scale),
- two indicators on the funnel (in different colors) for recording weekly, monthly, or annual rainfall,
- the collector allows recording cumulative rainfall up to 250 mm (250 l/m<sup>2</sup>),
- conical design of the mounting ring ensures optimal positioning of the rain gauge relative to falling rain as a measuring device,
- rain gauge protected by Patent No. 218270,
- rain gauge packaging protected by Industrial Design No. 18572,
- measuring device with a storm scale protected by EUIPO No. 008303481-0001,
- option to add custom printing,

**NEW!**

**Rain gauges in a new color, now even more visible**





## Thermometer SOIL - EKO

T000001E  
MOQ 50 pcs.

version 19 cm

version 40 cm



probe 11 cm



probe 11 cm



Scan



## Thermometer SOIL - STANDARD

T000002S  
MOQ 50 pcs.

version 19 cm

version 40 cm



probe 11 cm



probe 11 cm

SET INCLUDES:



thermometer

packaging  
- plastic bag



bucket clip

OR



wall bracket -  
self-adhesive

SET INCLUDES:

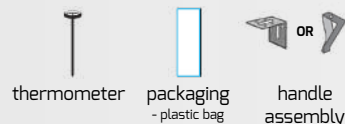

thermometer

packaging  
- plastic bag

handle  
assembly

## Thermometer SOIL - PREMIUM

T000003P  
MOQ 50 pcs.

version 19 cm



bucket clip



wall bracket - self-adhesive



probe 11 cm

probe 11 cm



THE PREMIUM SET INCLUDES:

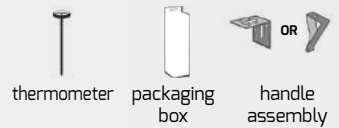

Soil thermometers with a shorter needle (19 cm version) are used for measuring soil temperature (prior to sowing temperature-sensitive seeds) as well as for measuring water temperature (e.g., for calf watering) and air temperature (e.g., in barns).

Agricultural thermometers with a longer needle (40 cm version), on the other hand, are used for measuring the temperature of silage.

The dial of the agricultural thermometer provides an excellent space for printing a logo.



Soil temperature



Temperature of water



Air temperature



Mounting bracket



Handle for mounting on the bucket



## Thermometer Thermo 19/27

THERM01  
MOQ 100 pcs.



Scan

SET INCLUDES:



thermometer stand

box

Stylish thermometer for indoor use. It comes with a collapsible stand so that the thermometer can be placed anywhere, for example on a desk. The thermometer also has a hole that allows you to hang it on the wall. Recommended comfort zone temperatures: winter 19°C, summer 27°C.

## Oil can JUMBO 5 l

KOJ050001

MOQ 100 pcs.



Scan



JUMBO Measuring Can made from HDPE material with an embossed scale (liters and US quarts), featuring a flexible spout tip and a closing lid. Measurement range: **0,5 liters / 0,5 quarts**  
Maximum capacity: **5 liters**

Custom logo printing available in a chosen **PANTONE** color.

The jug is suitable for:

- Oils
- Gasoline
- Kerosene
- Antifreeze mixtures
- Brake fluid
- Electrolytes

## Knife LIZARD

NL00001

MOQ 100 pcs.



Scan

A small, ergonomic and handy knife for opening envelopes and packages.

Pocket knife Lizard is intended for everyday use by everyone and also for companies in logistics departments.

Logo printing possible.



## Cleaning brush NOZZLE+

SZ00001



Scan

Can be attached to a lanyard



**STANDARD COLORS:**   
 MOQ 100 pcs.    White   Red   Green   Blue   Yellow

**COLORS OTHER:**   
 MOQ 1000 pcs.    Different

Professional cleaning brush for nozzles. Every nozzle operator must have it in his pocket. On the short side are two faults, which measure the diameter of following caps: **RAU - 17 mm** and **ARAG - 19 mm**.

There is also a notch for setting the nozzle at an angle of **8 degrees**. Next to the small hole are two insets.

This is also the key, that facilitates the tightening the cap to the nozzles with a width of **8 mm or 11 mm**.



## Dial caliper MIL+

S000001

MOQ 100 pcs.



Scan

Practical, plastic dial caliper with inch scale.  
 Measuring range: **0~150 mm**  
 Accuracy: **+/- 0,05 mm**  
 Measuring range: **0~5 in**  
 Accuracy: **+/- 1/128 in**  
 The logo and scale can be imprinted in a custom color from the PANTONE color palette.



## Seal SIBO

### COLORS

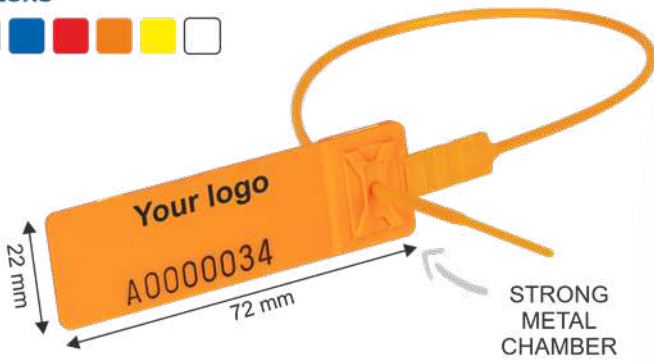

### EXAMPLE PRINTS FOR SIBO AND SIBO-BAG SEALS

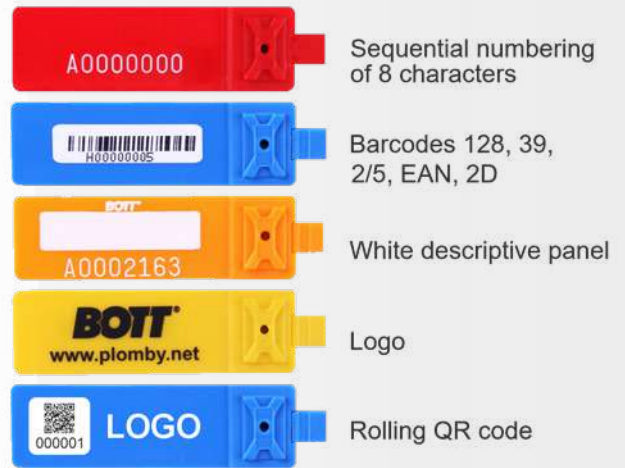

## Seal SIBO-L

### COLORS

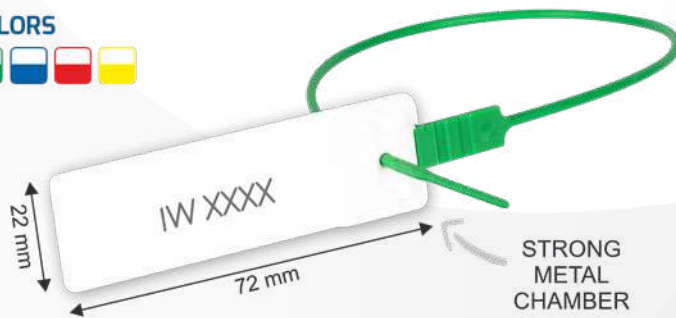

### FEATURES SEAL SIBO AND SIBO-L

- 330 mm length clamp seal
- diameter of strap 2,2 mm
- breaking strenght 180 N
- temperature range from -20 °C to + 80 °C
- made of PP
- strong metal chamber

### EXAMPLE PRINTS FOR SIBO-L SEALS

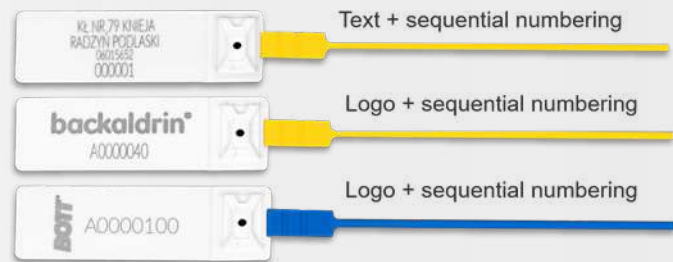

Scan

## Seal veterinary SIBO-TRACES

### COLORS

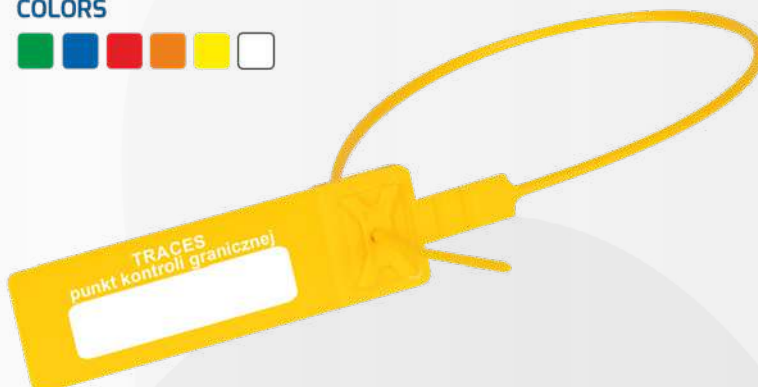

### PACKING SEAL SIBO, SIBO-L VETERINARY SIBO-TRACES

10 pcs. per blister

1 000 pcs. per box **KG** 5 kg  
dimensions of carton 57 x 27 x 14 cm

60 000 pcs. per euro palette **KG** 320 kg  
dimensions of palette 120 x 80 x 190 cm

#### Version 1

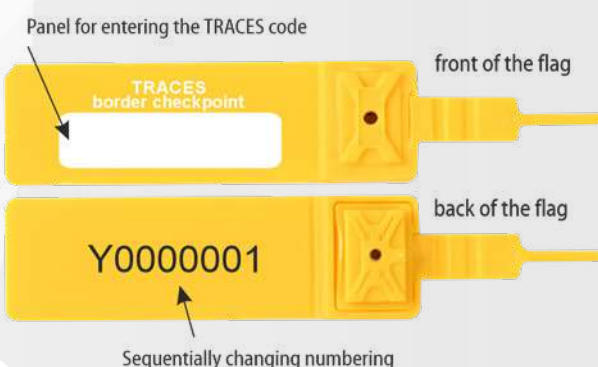

#### Version 2

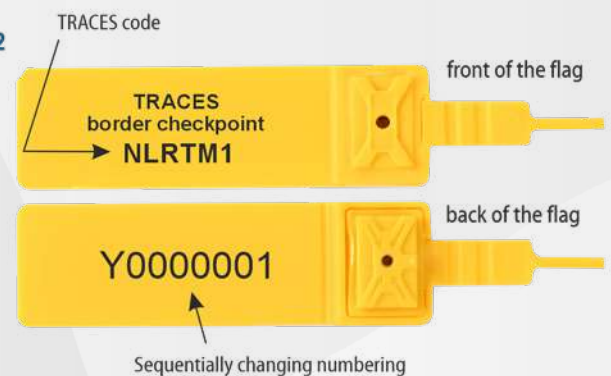

## Seal bag SIBO-BAG

### COLORS

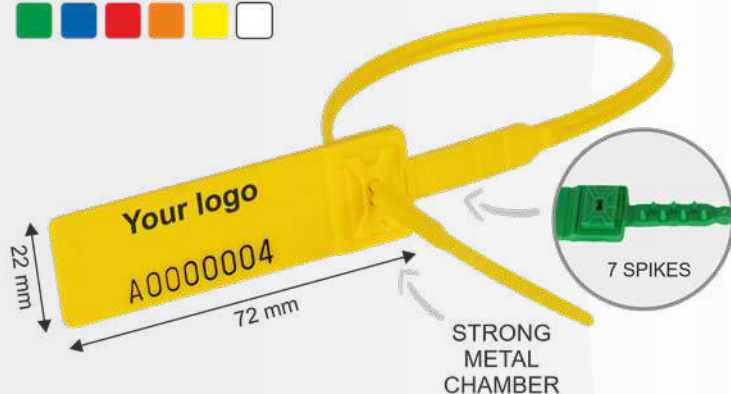

### FEATURES SEAL SIBO-BAG AND SIBO-BAG HUNTER

- 340 mm length clamp seal
- diameter of strap 2,2 mm x 5,2 mm
- breaking strength 400 N
- temperature range from -20 °C to + 80 °C
- made of PP
- strong metal chamber

### EXAMPLE PRINTS FOR SEAL SIBO-BAG

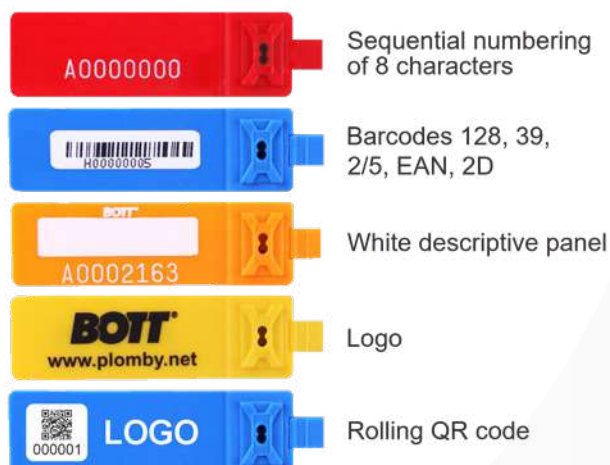

Scan

## Seal security BAG-BDS 01

### COLORS



### Printed schematics



1. Text line, max. 25 characters, font height 7
2. Text line, max. 25 characters, font height 7
3. Numeric barcode 128C for encoding max. 22 digits  
Code verified by REA MLV-2D verifier according to ISO/IEC 15416
4. Barcode recording from point 3 in human-readable version

## Seal bag SIBO-BAG HUNTER

### COLORS

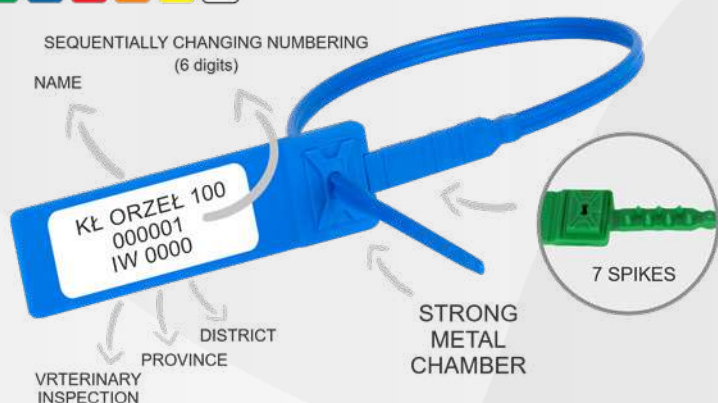

### PACKING SEAL SIBO-BAG, SECURITY BAG-BDS 01, SIBO-BAG HUNTER

- 10 pcs. per blister
- 1 000 pcs. per box **KG** 6 kg  
dimensions of box 57 x 27 x 14 cm
- 60 000 pcs. per euro palette **KG** 380 kg  
dimensions of palette 120 x 80 x 190 cm

## Veterinary marks and wild meat carcass markings

### Marks for venison carcasses KYR-IW

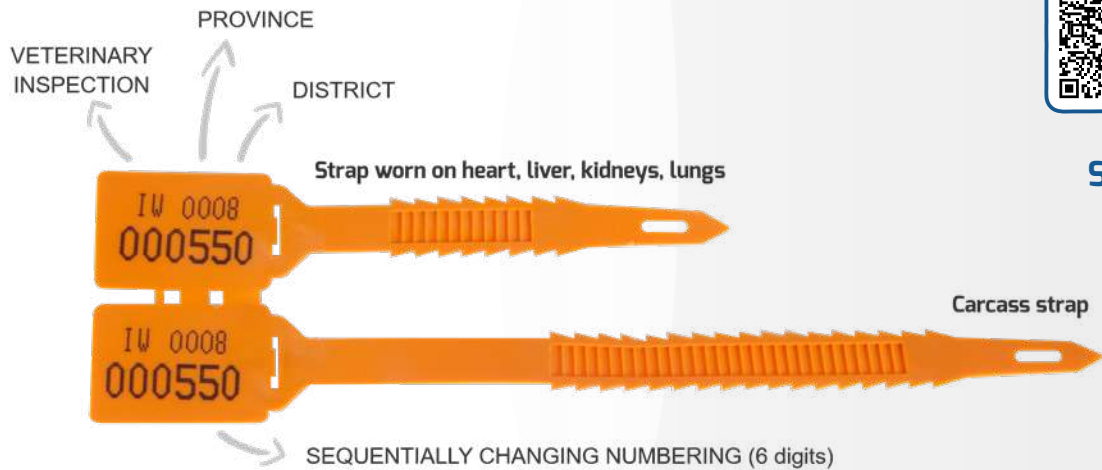

### Marks for venison carcasses KYR for licensed stores

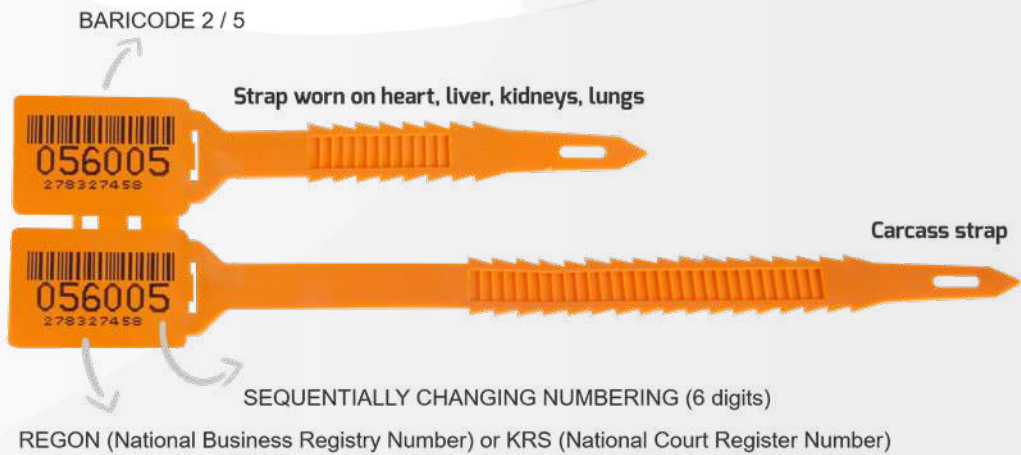

REGON (National Business Registry Number) or KRS (National Court Register Number)

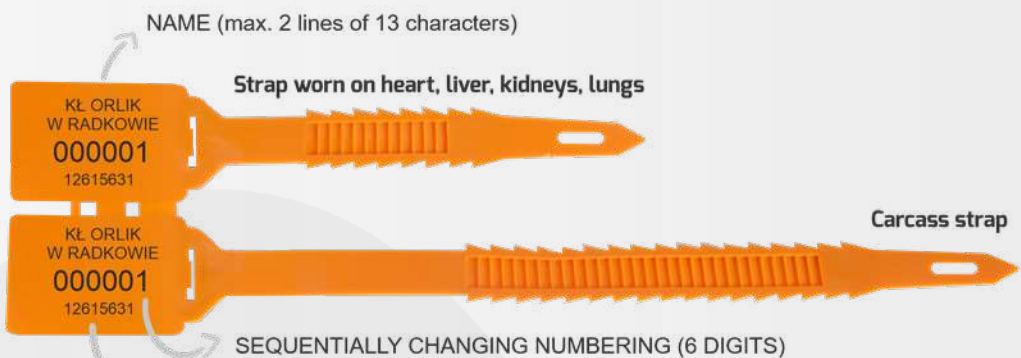

### Marks for venison carcasses KYR HUNTER dedicated to direct sales



DECISION NUMBER OF THE DISTRICT VETERINARY OR REGON (National Business Registry Number)

#### PACKING

 50 pcs. per package

 500 pcs. per box  5 kg  
dimensions of box 33 x 20 x 25 cm

#### COLORS



## Sealed sample bottles

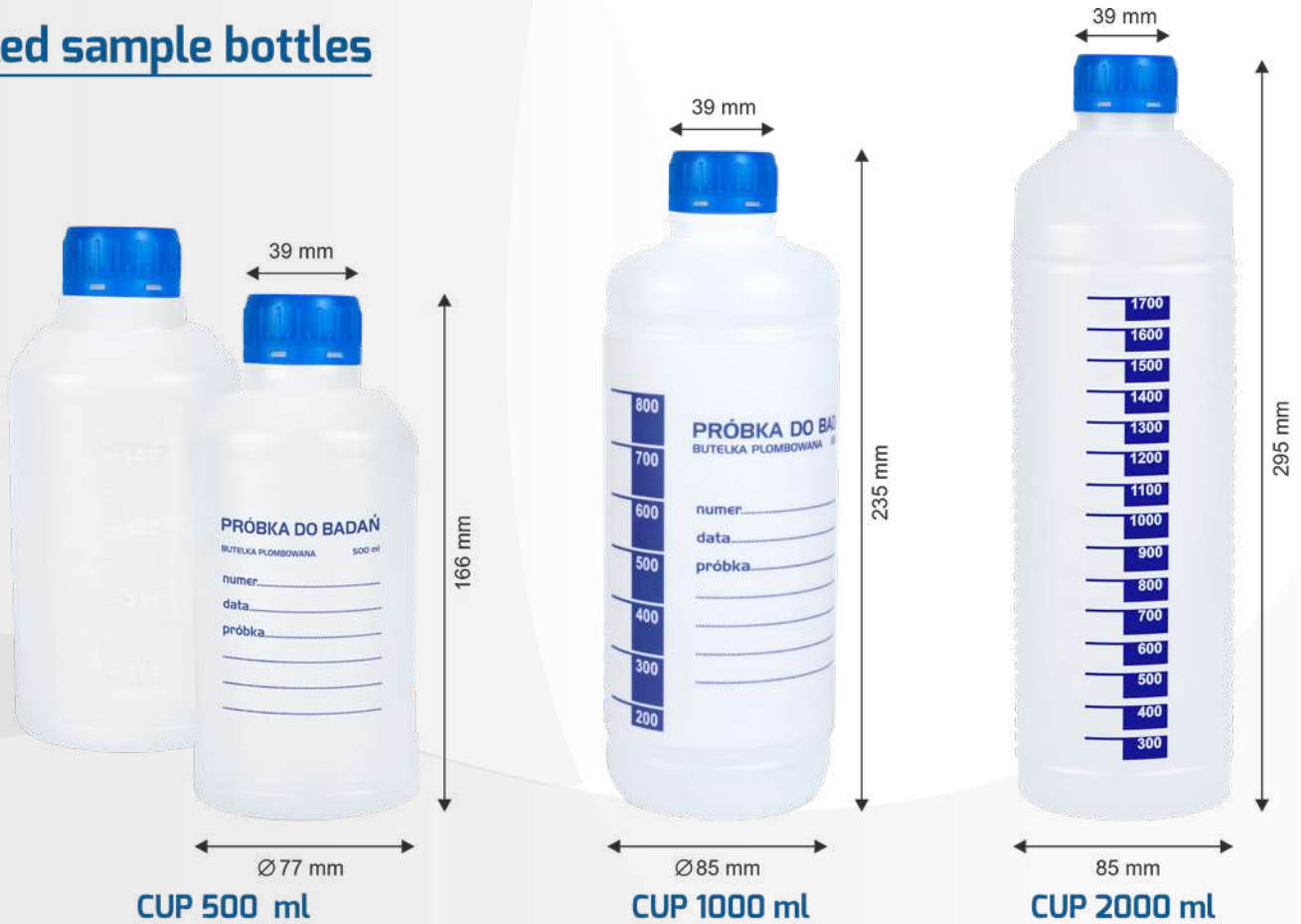

### ONE CAP FITS ALL BOTTLE SIZES



FACTORY OR CUSTOM NUMBERING

### FEATURES

- the cap breaks the sealing ring at opening attempt
- prevents access to the contents of the bottle to unauthorized people
- turning force minimum 4.0 Nm

### USAGE

- storage of low octane fuel samples like diesel, food products, chemicals
- protection of liquid and loose products
- used by hospitals, laboratories, gas stations, shipyards, sea transport

### BENEFITS

- unique numbering guarantees integrity, protects against industrial espionage and forgery
- bottles made material which meets the materials requirements intended to come into contact with food
- very easy assembly without any tools
- different cap colors make it easy to identify samples
- unique numbering allows for better control and ensures the integrity of samples



Scan

### PACKING

#### Bottles 500 ml

50 pcs. per box 2,5 kg  
dimensions of box 59 x 23 x 46 cm

#### Bottles 1000 ml

50 pcs. per box 4 kg  
dimensions of box 66 x 35 x 53 cm

100 pcs. per box 8 kg  
dimensions of box 62 x 42 x 70 cm

#### Bottles 2000 ml

50 pcs. per box 4 kg  
dimensions of box 59 x 23 x 46 cm

## Seal SIBO-ROTO CLEAR

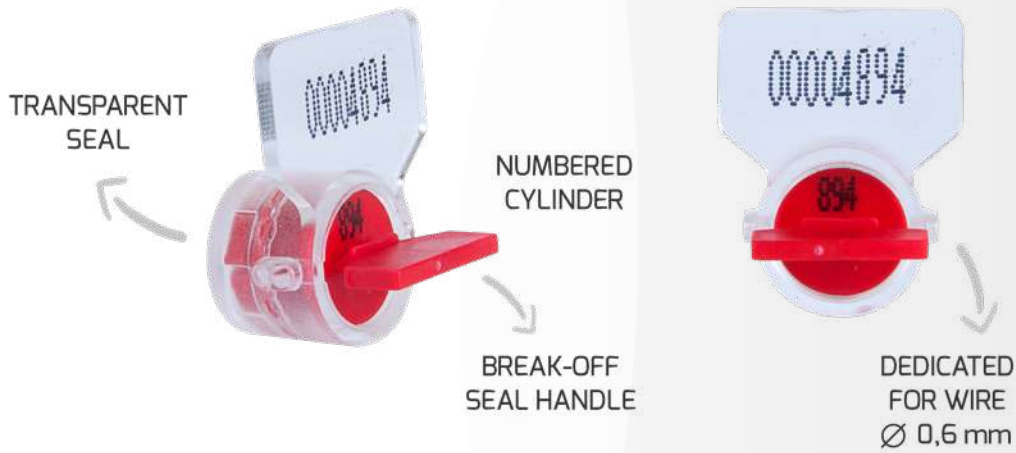

## Seal SIBO-ROTO WHITE



### FEATURES

- dedicated for Ø0,6 mm wire, e.g. String 600
- 0,6 mm string breakout force 200 N
- wing seal with individually adjustable operational length
- made of polycarbonate (PC) / POM
- temperature range from -20°C to +80°C
- wire sold separately

### COLORS



### PACKING

100 pcs. in plastic bag

2 000 pcs. per box **KG** 3 kg  
dimensions of box 57 x 27 x 14 cm

## Sealing wire STRING 600



### USAGE

- designed for use as a complementary component for butterfly seals, such as SIBO-ROTO
- securing measuring devices, warehouses, and vehicles
- to be cut into appropriate lengths according to individual requirements

### FEATURES

- pcv coated stainless steel wire, so it doesn't stratify
- diameter Ø0,6 mm
- available in 25 meters rolls
- 100 N breaking force

## Seal SIBO-PASTIL 10

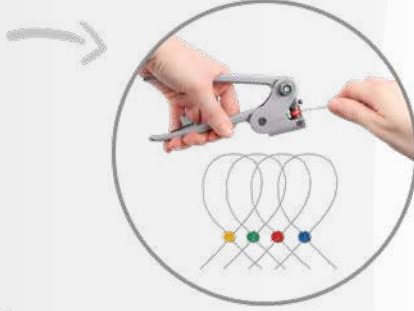

### COLORS



- compatible with any crimper tool
- requires no special reprocessing procedures unlike lead seals
- can be used with sealing wire, cord, line of any length
- 18 x lighter than lead seal

### PACKING



100 pcs. in plastic bag



100 000 pcs. per box



28 kg

dimensions of box 57 x 27 x 14 cm

## EPS sachet seals



### COLORS



### PACKING



10 pcs. per blister



250 pcs. per packet



5 000 pcs. per box



550 kg

dimensions of box 20 x 20 x 13 cm

## Sealed sachets CRYPTEX



### DIMENSIONS

S01 160 x 160 mm

S02 220 x 150 mm

S04 320 x 260 mm

### FEATURES

- unique sealing chamber, compatible with EPS seals
- made from durable KODURA polyester - a type of multi-layer fabric
- transparent outer pocket, with access only from inside the sachet
- available in blue



Scan













## Manual crimping tool ZA-01 for SIBO-BAG seals



### FEATURES AND BENEFITS

- designed for sealing SIBO BAG bags
- increased efficiency with minimum effort
- works especially when closing Big-Bags on the production line, e.g. manufacturers of artificial fertilizers
- they are HEAVY DUTY tools
- robust steel construction
- ergonomically shaped
- manual guillotine

## List of seals

		TAIL	TENSILE STRENGTH	IMPRINT
<b>SIBO</b> <b>SIBO-IW</b> <b>SIBO-TRACES</b>		 Ø 2,2 mm	180 N	hot-stamping inkjet
<b>SIBO-L</b>		 Ø 2,2 mm	180 N	laser
<b>SIBO-BAG</b> <b>SIBO-BAG HUNTER</b> <b>SECURITY BAG-BDS 01</b>		 2,2 x 5,2 mm	400 N	hot-stamping inkjet
<b>EPS</b>				inkjet
<b>SIBO-ROTO CLEAR</b>		 Ø 0,6 mm	200 N	inkjet pad printing
<b>SIBO-ROTO WHITE</b>		 Ø 0,6 mm	200 N	inkjet pad printing
<b>SIBO-PASTIL 10</b>		 max Ø 1,8 mm		
<b>KYR</b> <b>KYR-IW</b> <b>KYR-HUNTER</b>		 4 x 1,1 mm		inkjet



## AP 001 TYVEK® SLIM 19 mm

MOQ 100 pcs.

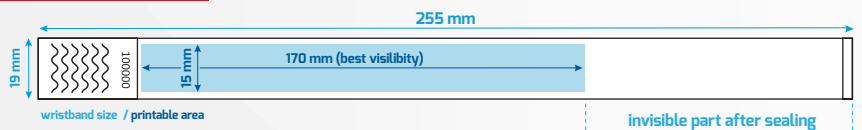

One-Day Adhesive Wristband Made of TYVEK® (**Slim Version, 19 mm Width**).

TYVEK® is a lightweight, waterproof, and tear-resistant material made from polyester fibers, resembling paper. Its durable color and unique factory numbering add extra value to this product. The print does not affect the quality of the wristband.

Logo printing: **screen printing**

Individual numbering, barcodes, or QR codes: **inkjet printing**

Neon colors glow under UV light.

Available colors according to the PANTONE pattern book:



Scan

## AP 006 TYVEK® WIDE 25 mm

MOQ 100 pcs.

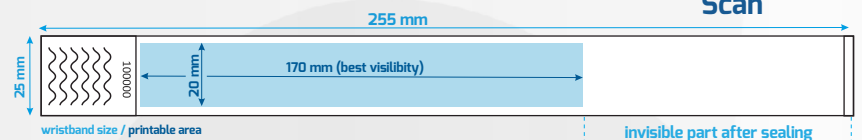

One-Day Adhesive Wristband Made of TYVEK® (**wide Version, 25 mm Width**).

TYVEK® is a lightweight, waterproof, and tear-resistant material made from polyester fibers, resembling paper. Its durable color and unique factory numbering add extra value to this product. The print does not affect the quality of the wristband.

Logo printing: **screen printing**

Individual numbering, barcodes, or QR codes: **inkjet printing**

Neon colors glow under UV light.

Available colors according to the PANTONE pattern book:

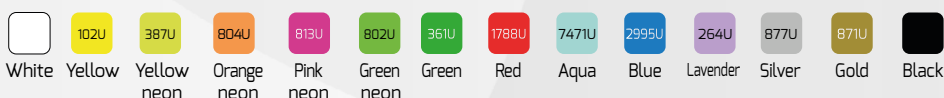

## AP 004 TYVEK® 1 TAB 25 mm

MOQ 100 pcs.



Available colors according to the PANTONE pattern book:

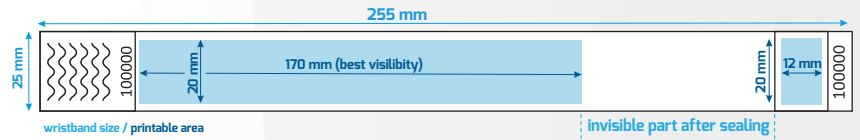
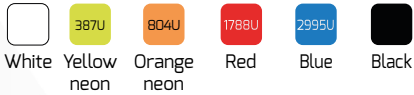

One-Day Adhesive Wristband Made of TYVEK® (**wide Version, 25 mm Width with coupon**).

TYVEK® is a lightweight, waterproof, and tear-resistant material made from polyester fibers, resembling paper. Its durable color and unique factory numbering add extra value to this product.

The print does not affect the quality of the wristband.

Logo printing: **screen printing**

Individual numbering, barcodes, or QR codes: **inkjet printing**

Neon colors glow under UV light.

## AP 024 ULTIMO FULL COLOR SLIM 19 mm

MOQ 100 pcs.



Print color:



Full Color CMYK



One-Day Adhesive Wristband Made of ULTIMO Paper (**Slim Version, 19 mm Width**)

ULTIMO paper is a thicker material with a textured, grainy surface. This product features full-color laser printing and unique factory numbering.

Printing method: **Digital (laser) printing** with a distinctive „dotting” effect.

## AP 025 ULTIMO FULL COLOR WIDE 25 mm

MOQ 100 pcs.



Print color:



Full Color CMYK

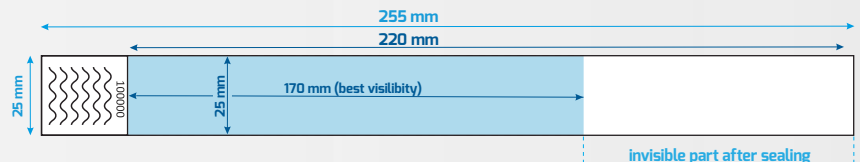

One-Day Adhesive Wristband Made of ULTIMO Paper (**Wide Version, 25 mm Width**).

ULTIMO paper is a thicker material with a textured, grainy surface. This product features full-color laser printing and unique factory numbering.

Printing method: **Digital (laser) printing** with a distinctive „dotting” effect.

## AP 026 TYVEK+ FULL COLOR SLIM 19 mm

MOQ 100 pcs.

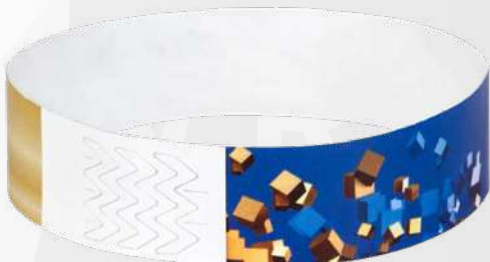

Print color:



Full Color CMYK



A single-use, self-adhesive band made of **Tyvek paper in a slim version, 19 mm wide**. TYVEK® is a paper-like material made from polyester yarn that is lightweight, waterproof, and tear-resistant. The band does not have a serial number.

Opaska nie posiada numeracji fabrycznej.

Printing: **digital (laser)**

## AP 003 VINYL SLIM 19 mm

MOQ 100 pcs.

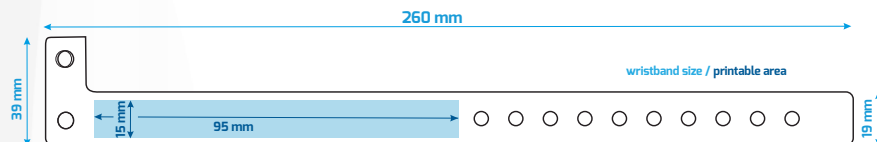

Few-Day Clasp Wristband Made of Vinyl (**Slim Version, 19 mm Width**). Vinyl is a highly durable material with mechanical strength, water resistance, and a characteristic sheen.

The print does not affect the quality of the wristband.

Logo printing: **Screen printing**

Individual numbering, barcodes, or QR codes: **Inkjet printing**

Neon colors glow under UV light.

Available colors according to the PANTONE pattern book:

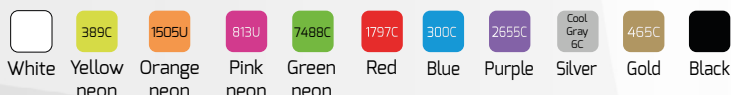

Scan

## AP 015 VINYL HOLOGRAM 19 mm

MOQ 100 pcs.

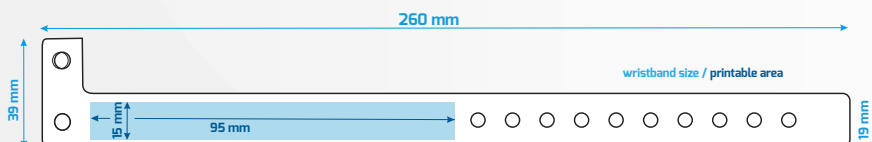

Few-Day Clasp Wristband Made of Vinyl (**Slim Version, 19 mm Width with a holographic effect**).

Vinyl is a highly durable material with mechanical strength, water resistance, and a characteristic sheen.

The print does not affect the quality of the wristband.

Logo printing: **Screen printing**

Individual numbering, barcodes, or QR codes: **Inkjet printing**

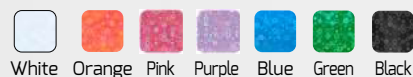

## AP 002 VINYL WIDE 25 mm

MOQ 100 pcs.

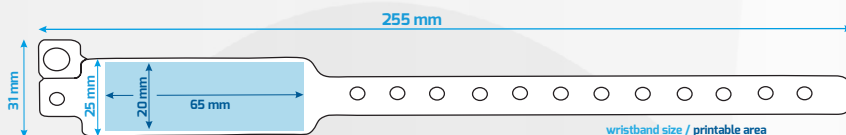

Few-Day Clasp Wristband Made of Vinyl (**Wide Version, 25 mm Width**). Vinyl is a highly durable material with excellent mechanical strength, water resistance, and a distinctive glossy finish.

The print does not affect the quality of the wristband.

Logo printing: **Screen printing**

Individual numbering, barcodes, or QR codes: **Inkjet printing**

Neon colors glow under UV light.

Available colors according to the PANTONE pattern book:



## AP 003 VINYL 3 TAB

MOQ 100 pcs.



Available colors according to the PANTONE pattern book:



## AP 005 VINYL 5 TAB

MOQ 100 pcs.



Available colors according to the PANTONE pattern book:



## AP 007 VINYL 7 TAB

MOQ 100 pcs.



Available colors according to the PANTONE pattern book:

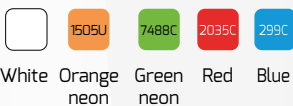

## AP 010 VINYL 10 TAB

MOQ 100 pcs.



Available colors according to the PANTONE pattern book:

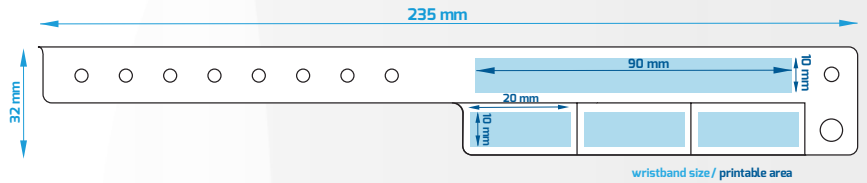
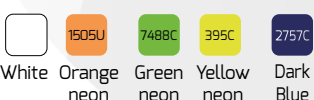

Few-Day Clasp Wristband Made of Vinyl **with 3 Tear-Off Coupons**. Vinyl is a highly durable material with excellent mechanical strength, water resistance, and a distinctive glossy finish. The print does not affect the quality of the wristband.

Logo printing: **Screen printing**

Individual numbering, barcodes, or QR codes: **Inkjet printing**

Neon colors glow under UV light.

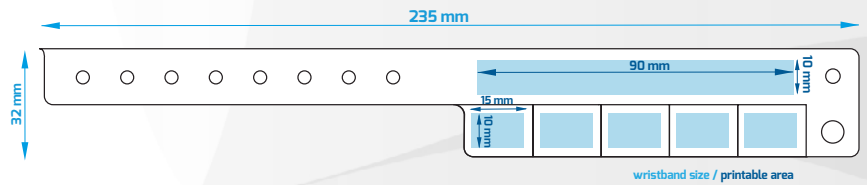

Few-Day Clasp Wristband Made of Vinyl **with 5 Tear-Off Coupons**. Vinyl is a highly durable material with excellent mechanical strength, water resistance, and a distinctive glossy finish. The print does not affect the quality of the wristband.

Logo printing: **Screen printing**

Individual numbering, barcodes, or QR codes: **Inkjet printing**

Neon colors glow under UV light.

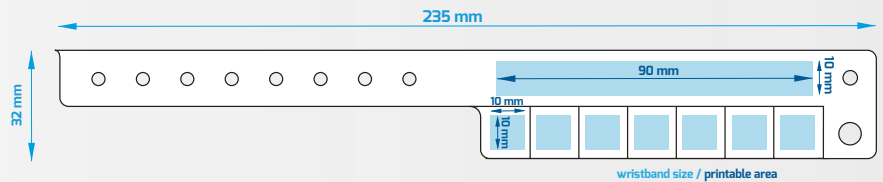

Few-Day Clasp Wristband Made of Vinyl **with 7 Tear-Off Coupons**. Vinyl is a highly durable material with excellent mechanical strength, water resistance, and a distinctive glossy finish. The print does not affect the quality of the wristband.

Logo printing: **Screen printing**

Individual numbering, barcodes, or QR codes: **Inkjet printing**

Neon colors glow under UV light.

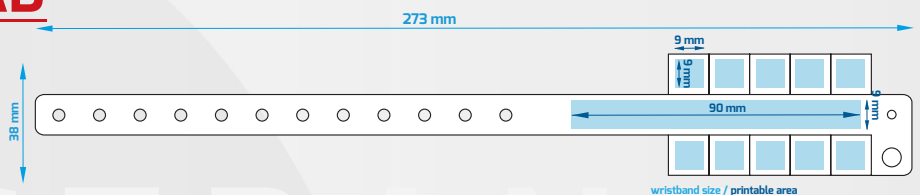

Few-Day Clasp Wristband Made of Vinyl **with 10 Tear-Off Coupons**. Vinyl is a highly durable material with excellent mechanical strength, water resistance, and a distinctive glossy finish. The print does not affect the quality of the wristband.

Logo printing: **Screen printing**

Individual numbering, barcodes, or QR codes: **Inkjet printing**

Neon colors glow under UV light.



Scan

## OP 007 SUBLIMATION WITH ALU LOCK

MOQ 100 pcs.



+ TAG



Print color:



Full Color  
CMYK

Fastener:



Aluminium

Wristband Made of Satin-Finish Polyester Ribbon. This wristband is designed for multi-color sublimation printing, a technique that ensures lasting color and pattern durability. Beyond identification, it serves as a memorable event keepsake.

To secure the wristband, slide the ALU clasp onto it and then tighten it using a ratchet seal press or hi-speed press (see page 40 for details).

+TAG PVC attached to the fabric wristband  
Print: **custom text, numbering, QR code**

Types of Tags:

	<p>TAG02 TAG03</p> <p>any text (LASER)</p>	<p>numbering (LASER)</p>	<p>code QR permanent code (LASER)</p>	<p>code QR rolling code (LASER)</p>
	<p>code QR permanent code (LASER)</p>	<p>LOGO (LASER)</p>	<p>LOGO (LASER)</p>	

Dimensions:

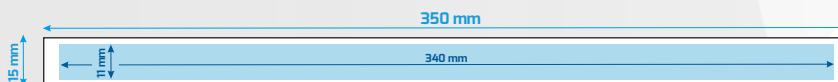

wristband size / secure printable area (project with margin 18 x 350 mm)

## OP 020 SUBLIMATION WITH SELFGRIP

MOQ 100 pcs.



+ TAG



Print color:



Full Color  
CMYK

Fastener:



Selfgrip  
black



Selfgrip  
white



Selfgrip  
white fluo



Wristband Made of Satin-Finish Polyester Ribbon. Designed for multi-color sublimation printing, this wristband offers long-lasting color and pattern durability. Beyond identification, it can also serve as an event souvenir.

The **SELFGRIP** clasp is pre-attached to the wristband and requires only tightening to a comfortable position once placed on the wrist. The clasp ensures a one-time closure with a one-way sliding mechanism.

+TAG PVC attached to the fabric wristband  
Print: **custom text, numbering, QR code**

Types of Tags:

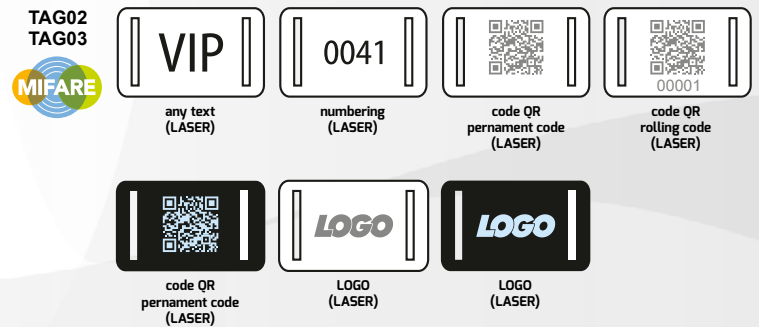

Dimensions:



## OP 024 SUBLIMATION WITH MULTICORAL

MOQ 100 pcs.



+ TAG



Stumble:



Full Kolor  
CMYK

Reusable fastener:



black  
multicoral



Wristband Made of Satin-Finish Polyester Ribbon. Designed for multi-color sublimation printing, this wristband offers long-lasting color and pattern durability. Beyond identification, it can also serve as an event keepsake.

The **MULTICORAL** clasp is pre-attached to the wristband and only requires tightening to a comfortable position when placed on the wrist. The clasp is adjustable in both directions, allowing the wristband to be removed and kept as a souvenir without damage („remove & keep”).

+TAG PVC attached to the fabric wristband  
Print: **custom text, numbering, QR code**

Types of Tags:

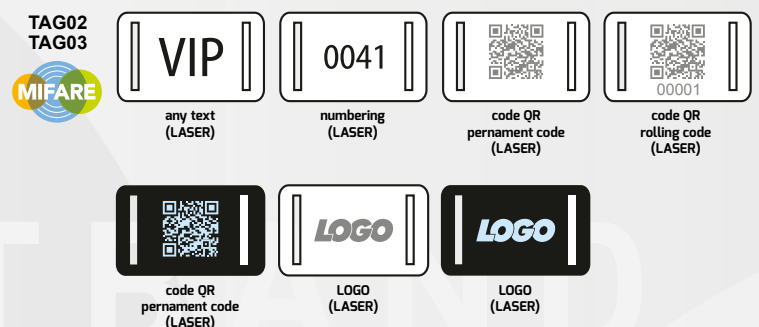

Dimensions:

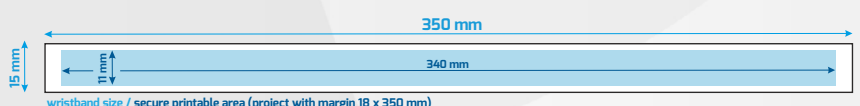

## CRIMPER TOOL



The ratchet mechanism ensures consistent clamping force for the aluminum clasp, regardless of the operator's strength when using the sealing tool.

**The sealing tool is designed for use with wristbands: OP007**



Scan

## CRIMPER TOOL HISPEED



The hi-speed sealing tool is perfect for large-scale festivals and concerts. It provides fast and consistent clamping of aluminum clasps, regardless of the operator's strength.

**The sealing tool is designed for use with wristbands: OP007**





## WAFFLE FESTIVAL TOKENS

MOQ 10 pcs.



Scan

### Where can You use our tokens?

- festival tokens, quick service guaranteed
- excellent non-cash currency for large events
- available in sheets of 40 pcs.
- possibility to break out smaller sheets of 20 pieces. (1 sheet is the size of 4 credit cards)
- practical hole, allows you to carry the sheet, e.g. a leash
- easy distribution, each chip has a special groove making it easy to break in half

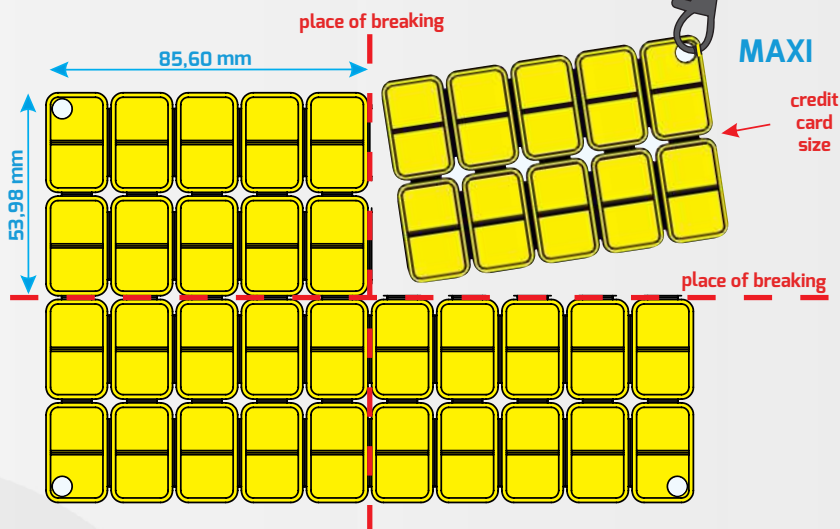

Available colors according to the PANTONE pattern book:



White Yellow Blue Green Black

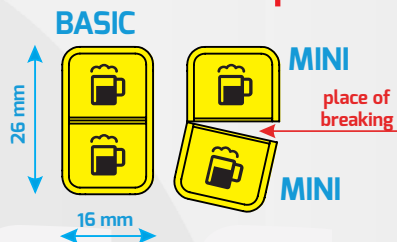

- 1 WAFFLE SHEET = 40 BASIC TOKENS OR 80 MINI TOKENS
- 1 WAFFLE SHEET = 4 X MAXI (CREDIT CARD SIZE)
- 1 MAXI = 10 BASIC TOKENS
- 1 BASIC TOKEN = 2 MINI TOKENS





**Where can You use our tokens?**

- NUMBER FOR CLOACKROOM
- CATERING, PICNICS, EVENTS
- WAY OF PAYMENT
- LOTTERIES
- VIP TICKETS
- FUNFAIRS
- ORCHARDS
- DOG COLLAR TAG
- TOKENS FOR SHOPPING CARDS

## TOKENS CHIP

MOQ 100 pcs.

**WITH HOLE**

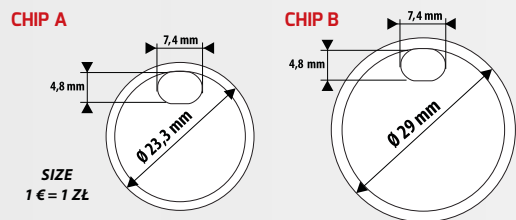

Available colors according to the PANTONE pattern book:

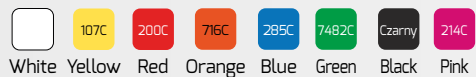

**WITHOUT HOLE**

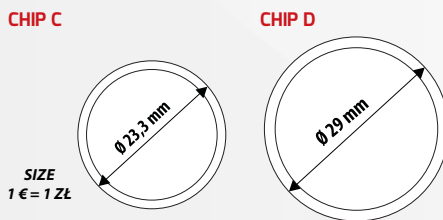

Available colors according to the PANTONE pattern book:

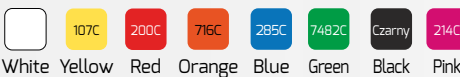

Scan

**Free of charge pictograms:**



## THE TOKEN TRAY

MOQ 1 pcs.



for 500 pcs. tokens

Fits all CHIP A, B, C, D

## FOB FOR TOKENS

MOQ 100 pcs.



Available colors according to the PANTONE pattern book:



## HANGER FOR TOKENS

MOQ 100 pcs.



suitable for 23.3 mm tokens

Available colors according to the PANTONE pattern book:

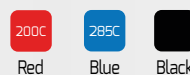



## CUPS NANO 200 ML / 400 ML

MOQ 100 pcs.



Scan



### Specifications:



made of chemical-resistant material

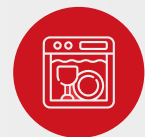

can be washed in dishwashers (up to: temp. +95°C)



freely customisable promotional prints, logos



individual measuring scales ml/g

Our NANO event cup, made of polypropylene, is an eco-friendly product that is easy to clean, even in dishwashers at temperatures up to 95°C. With the option to print any client logo, it becomes not only a practical tool but also an effective advertising medium and a marketing gadget for industry professionals.

Printing method: **Screen printing**



Catalog  
Online

# BOTT®

**BOTT sp. z o.o.**

ul. Budowlanych 8, 64-100 Leszno

NIP: PL 6972314982

phone: +48 65 529 48 08

e-mail: info@bott.pl

